

Flowflex[®] PLUS

COVID-19 and Flu A/B Home Test Quick Reference Instructions

REF L03A-R0645 REF L03A-R0745 REF L03A-R0845 REF L03A-R0945 English

For use under an Emergency Use Authorization (EUA) only. For in vitro diagnostics use. For use with anterior nasal swab specimens.

Carefully read all instructions before performing the test. Failure to follow the instructions may result in inaccurate results. A full IFU can be found at: www.flowflexcovid.com

An anterior nasal swab sample can be self-collected by an individual aged 14 years or older. Children aged 2-13 years should be tested by an adult.

KIT CONTENTS

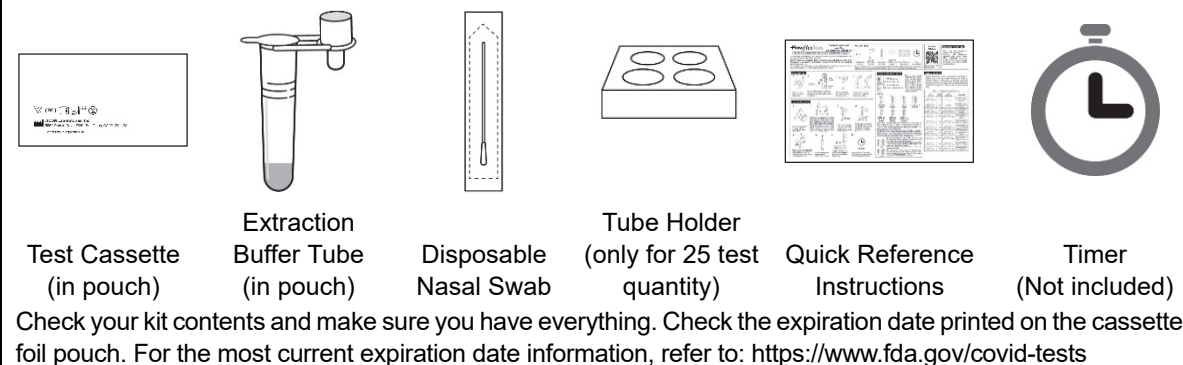

Flowflex QR Code



Scan to learn more about the test

RESULTS REPORTING

Report your test result(s) at MakeMyTestCount.org-this voluntary and anonymous reporting helps public health teams understand COVID-19 spread in your area and across the country and informs public health decisions.

PREPARATION

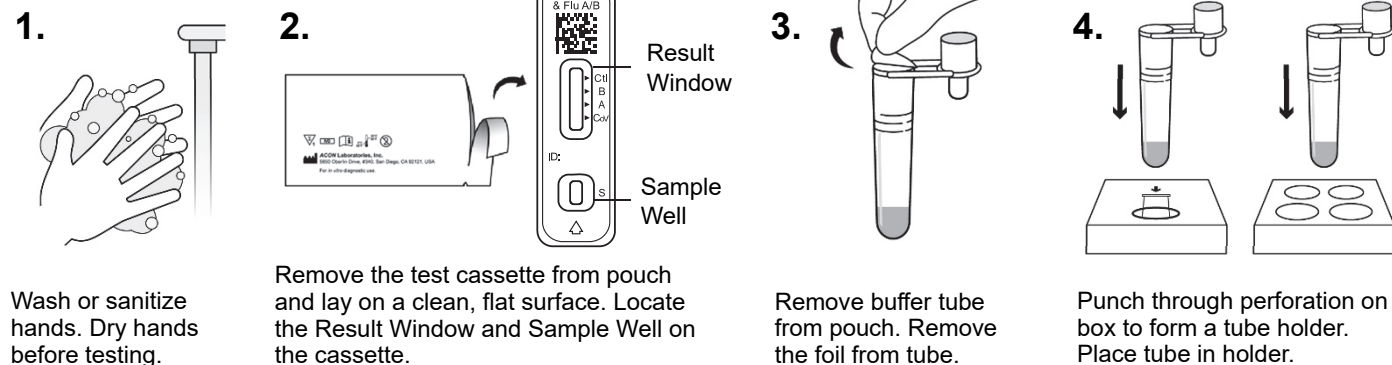

Wash or sanitize hands. Dry hands before testing.

Remove the test cassette from pouch and lay on a clean, flat surface. Locate the Result Window and Sample Well on the cassette.

Remove buffer tube from pouch. Remove the foil from tube.

Punch through perforation on box to form a tube holder. Place tube in holder.

TEST PROCEDURE

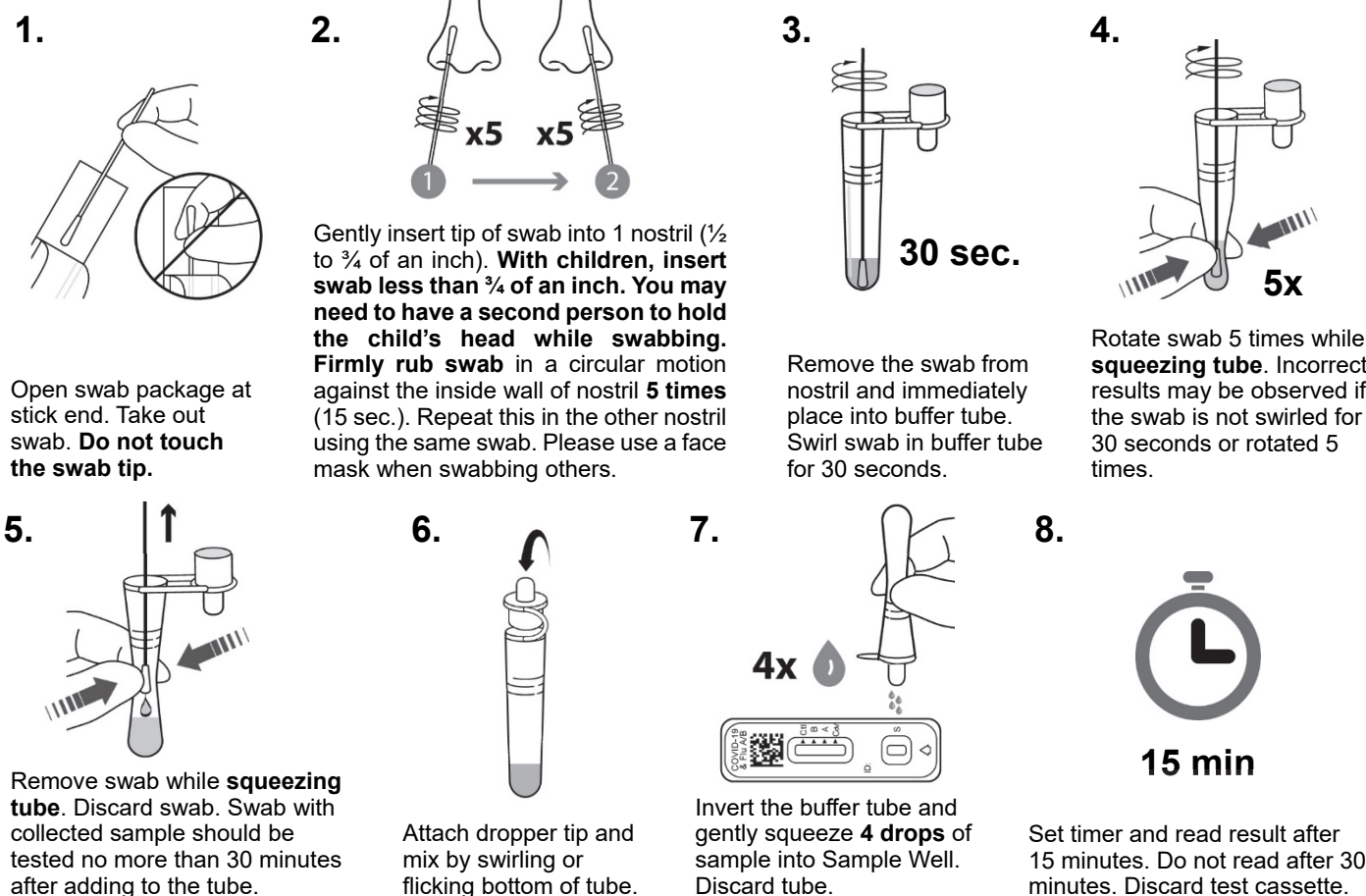

Open swab package at stick end. Take out swab. Do not touch the swab tip.

Gently insert tip of swab into 1 nostril (1/2 to 3/4 of an inch). With children, insert swab less than 3/4 of an inch. You may need to have a second person to hold the child's head while swabbing. Firmly rub swab in a circular motion against the inside wall of nostril 5 times (15 sec.). Repeat this in the other nostril using the same swab. Please use a face mask when swabbing others.

Remove the swab from nostril and immediately place into buffer tube. Swirl swab in buffer tube for 30 seconds.

Rotate swab 5 times while squeezing tube. Incorrect results may be observed if the swab is not swirled for 30 seconds or rotated 5 times.

Remove swab while squeezing tube. Discard swab. Swab with collected sample should be tested no more than 30 minutes after adding to the tube.

Attach dropper tip and mix by swirling or flicking bottom of tube.

Invert the buffer tube and gently squeeze 4 drops of sample into Sample Well. Discard tube.

Set timer and read result after 15 minutes. Do not read after 30 minutes. Discard test cassette.

RESULT INTERPRETATION

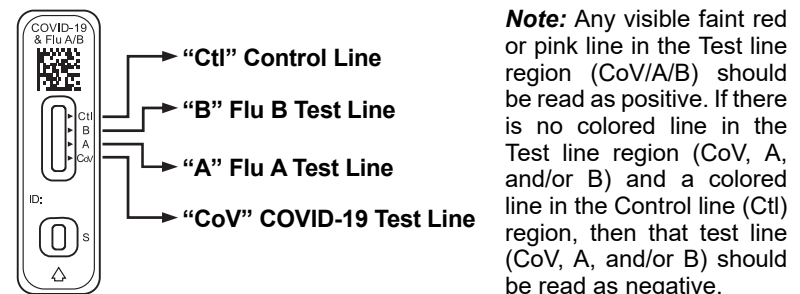

Positive

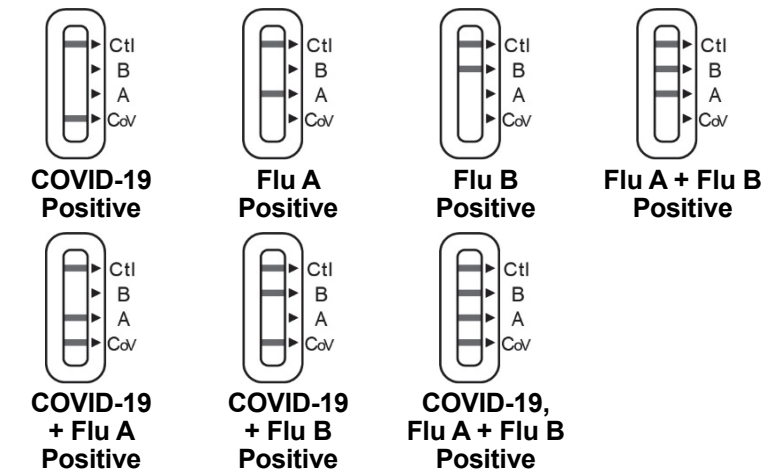

If the Control (Ctl) line is visible and any other line or multiple lines, no matter how faint, at "CoV", "A" and/or "B" appear, the test is positive for that virus. Repeat testing is needed for all samples that are negative for COVID-19 on the first day of testing, even if they are positive for Flu A and/or B (see SERIAL TESTING section). The COVID-19, Flu A and/or Flu B virus(es) were detected in your sample. It is very likely that you have the respective infection(s) and are contagious. Please contact your healthcare provider or your local health authorities and follow local guidelines for self-isolation. There is a small chance that this test can give you a positive result that is incorrect (a false positive).

Negative

If the Control (Ctl) line is visible, but the Test (CoV/A/B) line is not visible, the test is negative. The COVID-19, Flu A, or Flu B virus have not been detected. To increase the chance that the negative result for COVID-19 is accurate, you should test again in 48 hours after the first day of testing. If respiratory symptoms persist, seek follow-up care with a healthcare provider.

Invalid

If the Control (Ctl) line is not visible, even if any other line is visible in the result window, the test is not valid. Re-test with a new swab and a new test cassette. If the problem persists, call (800) 838-9502 for assistance.

SERIAL TESTING

Serial (repeat) testing is needed for all samples that are negative for SARS-CoV-2 on the first day of testing, even if they are positive for influenza A and/or B. Repeat testing is needed to improve test accuracy for SARS-CoV-2. Please follow the table below when interpreting test results. Serial testing does not need to be performed if patients have a positive SARS-CoV-2 result on the first day of testing.

Status on First Day of Testing: With Symptoms			
Day 0 (First Test)	Serial Testing?	Day 2 (Second Test)	Interpretation
SARS-CoV-2 (+), Influenza A and/or B (-)	NO	Not Needed	Positive for COVID-19, Presumptive Negative for Influenza
SARS-CoV-2 (+), Influenza A and/or B (+)	NO	Not Needed	Positive for COVID-19, Positive for Influenza A and/or B
SARS-CoV-2 (-), Influenza A and/or B (-)	YES	SARS-CoV-2 (+), Influenza A and/or B (-)	Positive for COVID-19, Presumptive Negative for Influenza
SARS-CoV-2 (-), Influenza A and/or B (+)	YES	SARS-CoV-2 (+), Influenza A and/or B (+)	Positive for COVID-19, Positive for Influenza A and/or B
SARS-CoV-2 (-), Influenza A and/or B (-)	YES	SARS-CoV-2 (-), Influenza A and/or B (+)	Presumptive Negative for COVID-19, Positive for Influenza A and/or B
SARS-CoV-2 (-), Influenza A and/or B (-)	YES	SARS-CoV-2 (-), Influenza A and/or B (-)	Presumptive Negative for COVID-19, Presumptive Negative for Influenza
SARS-CoV-2 (-), Influenza A and/or B (-)	YES	SARS-CoV-2 (+), Influenza A and/or B (+)	Positive for COVID-19, Positive for Influenza A and/or B
SARS-CoV-2 (-), Influenza A and/or B (+)	YES	SARS-CoV-2 (-), Influenza A and/or B (-)	Presumptive Negative for COVID-19, Positive for Influenza A and/or B
SARS-CoV-2 (-), Influenza A and/or B (+)	YES	SARS-CoV-2 (-), Influenza A and/or B (+)	Presumptive Negative for COVID-19, Positive for Influenza A and/or B
SARS-CoV-2 (-), Influenza A and/or B (+)	YES	SARS-CoV-2 (+), Influenza A and/or B (+)	Positive for COVID-19, Positive for Influenza A and/or B

INTENDED USE

The Flowflex Plus COVID-19 and Flu A/B Home Test is a lateral flow immunoassay intended for the qualitative detection and differentiation of SARS-CoV-2, influenza A, and influenza B protein antigens.

This test is authorized for non-prescription home use with self-collected anterior nares nasal swab specimens from individuals aged 14 years or older, or with adult-collected anterior nasal swab specimens from individuals two (2) years or older.

This test is only authorized for individuals with sign and symptoms of respiratory infection consistent with COVID-19 within the first six (6) days of symptom onset when tested at least twice over three days with at least 48 hours between tests.

Clinical signs and symptoms of respiratory viral infection due to SARS-CoV-2 and influenza can be similar.

Results are for the simultaneous identification of SARS-CoV-2, influenza A virus, and influenza B virus protein antigens, but do not differentiate between SARS-CoV and SARS-CoV-2 viruses and are not intended to detect influenza C antigens.

The viral antigens targeted by this test are generally detectable from specimens collected using nasal swabs during the acute phase of infection. Positive results indicate the presence of viral antigens, but the clinical correlation with patient history and other diagnostic information is necessary to determine infection status.

Positive results do not rule out bacterial infection or co-infection with other viruses. The agent detected may not be the definitive cause of the disease. Individuals who test positive with the Flowflex Plus COVID-19 and Flu A/B Home Test should self-isolate and seek follow up care with their physician or healthcare provider as additional testing may be necessary.

All negative results are presumptive and confirmation with a molecular assay, if necessary for patient management, may be performed. Negative results do not rule out SARS-CoV-2, influenza A, and influenza B infection and should not be used as the sole basis for treatment or patient management decisions, including infection control decisions such as isolating from others and wearing masks. Negative results should be considered in the context of an individual's recent exposures, history, and the presence of clinical signs and symptoms consistent with SARS-CoV-2, influenza A, and influenza B infection.

Individuals who test negative and continue to experience SARS-CoV-2 and/or influenza-like symptoms of fever, cough and/or shortness of breath may still have SARS-CoV-2 and/or influenza infection and should seek follow up care with their physician or healthcare provider.

The Flowflex Plus COVID-19 and Flu A/B Home Test is only for use under the Food and Drug Administration's Emergency Use Authorization.

STORAGE AND HANDLING

- Store Flowflex Plus COVID-19 and Flu A/B Home Test between 2-30°C (36-86°F) until use. The test should be performed in an environment between 15-30°C (59-86°F) and with good lighting.
- Kit contents are stable until the expiration date printed on the outer packaging and should not be used beyond the expiration date.

WARNINGS, PRECAUTIONS, AND SAFETY INFORMATION

- Read the instructions fully and carefully before performing the test. Failure to follow the instructions may result in inaccurate test results.
- This test may only be used in symptomatic individuals.
- In the USA, this product has not been FDA cleared or approved, but has been authorized by FDA under an Emergency Use Authorization. This product has been authorized only for the detection of proteins from SARS-CoV-2, influenza A, and influenza B, not for any other viruses or pathogens. The emergency use of this product is only authorized for the duration of the declaration that circumstances exist justifying the authorization of emergency use of in vitro diagnostics for detection and/or diagnosis of COVID-19 under Section 564(b)(1) of the Federal Food, Drug, and Cosmetic Act, 21 U.S.C. § 360bbb-3(b)(1), unless the declaration is terminated or authorization is revoked sooner.
- Serial testing should be performed in symptomatic individuals with SARS-CoV-2 negative results at least twice over three days (with 48 hours between tests). You may need to purchase additional tests to perform this serial (repeat) testing.**
- Consistent with serial testing recommendations for SARS-CoV-2, for multi-analyte tests, symptomatic individuals who test positive for influenza A or B on the initial test but test negative for SARS-CoV-2 should be tested again in 48 hours to evaluate for co-infection with SARS-CoV-2 infection.**
- This test is read visually. Individuals with impaired vision or color-impaired vision should seek help in interpretation of their test results.
- Do not use the test after the expiration date shown on the test cassette pouch or if the test kit contents are damaged or opened.
- Wear a safety mask or other face-covering when collecting a specimen from a child or another individual.
- Do not use on anyone under 2 years of age.
- The swab specimen should be processed and tested immediately after collection.
- Leave the test cassette sealed in its pouch until just before use.
- Once opened, the test cassette should be used within 60 minutes to prevent false test results.

- Do not use nasal sprays for at least 30 minutes before collecting a nasal sample as this may lead to incorrect results.
- Follow the instruction carefully; false negative test results may occur if a specimen is incorrectly collected or handled.
- Do not read test results before 15 minutes or after 30 minutes. Results read before 15 minutes or after 30 minutes may lead to a false positive, false negative, or invalid result.**
- Test components are single-use. Do not re-use the test cassette, buffer liquid, or swab.
- Keep testing kit and components away from children and pets before and after use. Avoid contact with your skin, eyes, nose, and mouth. Do not ingest any kit components as the reagent solution contains harmful chemicals (see table below).**
- If the reagent solution contacts the skin, eyes, nose, or mouth, flush with large amounts of water.**
- If irritation persists, seek medical advice:**
<https://www.poisonhelp.org> or 1-800-222-1222.

Hazardous Ingredients for the Reagent Solution			
Hazard Category (mixture)	GHS Hazard Statement for mixture	Labeling of Harm(s)	Hazardous Ingredients (%)
2	Skin irritation	Causes skin irritation (H315)	<ul style="list-style-type: none">Proclin 300 / 0.02%Tris / 1%
2	Eye irritation	Causes eye irritation (H320)	<ul style="list-style-type: none">Proclin 300 / 0.02%Tris / 1%

- For more information on EUAs please visit: <https://www.fda.gov/emergency-preparedness-and-response/mcm-legal-regulatory-and-policy-framework/emergency-use-authorization>
- For the most up to date information on COVID-19, please visit: <http://www.cdc.gov/COVID19>

LIMITATIONS

- The performance of this test was established based on the evaluation of a limited number of clinical specimens collected between December 2022 and March 2024. The clinical performance has not been established for all circulating variants but is anticipated to be reflective of the prevalent variants in circulation at the time and location of the clinical evaluation. Performance at the time of testing may vary depending on the variants circulating, including newly emerging strains of SARS-CoV-2 and their prevalence, which change over time
- There is a higher chance of false negative results with antigen tests than with laboratory-based molecular tests due to the sensitivity of the test technology. This means that there is a higher chance this test will give a false negative result in an individual with COVID-19 and influenza as compared to a molecular test, especially in samples with low viral load.
- All negative results with this test are presumptive and confirmation with a molecular assay may be necessary.
- Incorrect test results may occur if a specimen is incorrectly collected or handled.
- If you continue to have symptoms consistent with COVID-19 and influenza, and both your first and second tests are negative, you may not have COVID-19 or influenza, however you should follow-up with a healthcare provider.
- If your test is positive, then proteins from the viruses that cause COVID-19 or influenza have been found in the sample and the individual likely has respiratory infection with SARS-CoV-2 or influenza.
- Individuals who recently received nasally administered influenza A or influenza B vaccine may have false positive test results after vaccination.
- This test is read visually and has not been validated for use by those with impaired vision or color-impaired vision.

FREQUENTLY ASKED QUESTIONS

Q: WHAT ARE THE KNOWN POTENTIAL RISKS AND BENEFITS OF THIS TEST?

A: Potential risks include:

- Possible discomfort during sample collection.
- Possible incorrect test results (see Warnings and Result Interpretation sections for more information).

Potential benefits include:

- The results, along with other information, can help you and your healthcare provider make informed recommendations about your care.
- The results of this test may help limit the spread of COVID-19 and flu to the family of the tested individual and others in your community.

Q: WHAT IS THE DIFFERENCE BETWEEN AN ANTIGEN AND MOLECULAR TEST?

A: There are different kinds of tests for the viruses that cause COVID-19 and the flu. Molecular tests detect genetic material from the virus. Antigen tests, such as the Flowflex Plus COVID-19 and Flu A/B Home Test, detect proteins from the virus. Due to the lower sensitivity of antigen tests, there is a higher chance this test will give you a false negative result when you have COVID-19 than a molecular test would.

Q: WHAT IF I HAVE A COVID-19 POSITIVE TEST RESULT?

A: A positive result means that it is very likely you have COVID-19 because proteins from the virus that causes COVID-19 were found in your sample. You should self-isolate from others and contact a healthcare provider for medical advice about your positive result.

Q: WHAT IF I HAVE A COVID-19 NEGATIVE TEST RESULT?

A: A negative test result indicates that antigens from the virus that causes COVID-19 were not detected in your sample. However, if you have symptoms of COVID-19, and your first test is negative, you should test again in 48 hours since antigen tests are not as sensitive as molecular tests. If you do not have symptoms and received a negative result, you should test at least two more times with 48 hours in between tests for a total of three tests. If you have a negative result, it does not rule out SARS-CoV-2 infection; you may still be infected and you may still infect others. It is important that you work with your healthcare provider to help you understand the next steps you should take.

Q: HOW ACCURATE IS THIS TEST?

A: Clinical studies have shown that antigen tests more accurately determine whether you are infected with the virus that causes COVID-19 when taken multiple times across several days. Repeat testing improves test accuracy. This serial testing approach is recommended to minimize the risk of incorrect results. For more information on the performance of the test and how the performance may apply to you, please refer to the performance data in the Healthcare Provider Instructions for Use (IFU), available at flowflexcovid.com

Q: WHAT DOES AN INVALID TEST RESULT MEAN?











A: An invalid result means the test was not able to tell if you have COVID-19 and influenza infection or not. If the test is invalid, a new swab should be used to collect a new nasal specimen and you should test again with a new test.

For further information on the disease and epidemiology, please visit the CDC website.

IMPORTANT

Do not use this test as the only guide to manage your illness. Please consult your healthcare provider if your symptoms persist or become more severe, or if you are concerned at any time.

Index of Symbols

	Manufacturer		Date of manufacture
	Contains sufficient for <n> tests		Catalogue number
	In vitro diagnostic medical device		Use-by date
	Consult instructions for use		Batch code
	Temperature limit		Do not reuse



ACON Laboratories, Inc.
5850 Oberlin Drive, #340
San Diego, CA 92121, USA
flowflexcovid.com
Customer Support: 1-800-838-9502